



Collezione porte
LINEA INCISE



Versione 0017



AZIENDA CON SISTEMA DI QUALITÀ
CERTIFICATO UNI EN ISO 9001





LA NOSTRA AZIENDA

Sin dal 1976 la nostra azienda si dedica alla progettazione e produzione di porte di altissimo pregio, dagli elevati valori prestazionali e in una vasta gamma di modelli, finiture, essenze e laccati.

Costruite attraverso sistemi tecnologici all'avanguardia, le porte Il Legno si distinguono per gli elevati standard qualitativi caratteristici delle lavorazioni artigianali Made-in-Italy, grazie a cui è possibile realizzare prodotti esclusivi e su misura, a seconda delle esigenze del cliente, in grado di unire design, funzionalità, sicurezza ed affidabilità a lungo termine.

La selezione delle migliori materie prime nel pieno rispetto dell'ambiente, la consulenza tecnica fornita da esperti e la puntualità del servizio sono i principali fattori che nel corso del tempo hanno contribuito a rafforzare una filosofia aziendale basata sulla piena soddisfazione del cliente.

Le porte Il Legno sono in grado di armonizzarsi a qualsivoglia tipologia di ambiente, stile d'arredamento o preferenza estetica grazie all'ampio ventaglio di materiali, finiture e accessori offerti, ciascuno dei quali si contraddistingue per qualità e cura nei dettagli, entrambi elementi cardine nella realizzazione di ogni singolo prodotto.

La produzione Il Legno è inoltre completata da armadiature, complementi d'arredo e boiserie su misura, che consentono di realizzare ambienti dall'elevato valore funzionale ed estetico.



COLLEZIONE "LINEA INCISE"

Telaio in legno listellare spessore mm. 40 raggio 3 con battuta e guarnizione, fresate per incastro coprifili.

Coprifili da mm. 70x10 lato interno e da mm. 90x10 lato bello porta, entrambi con aletta ad incastro.

Ante spessore mm. 44 con massello perimetrale in abete giuntato FJ per eliminare nodi e risacche di resina, battuta tre lati, supporti da mm. 4/5, alveolare in cartone resinato pesante a foro 20/25, tappi di rinforzo altezza serratura.

Ferramenta cromo satinato, cerniere anuba da 14, tre per anta per le incise, incise pesanti cerniere 3D. Serratura magnetica per entrambe le versioni.

Lavorazione profonda mm. 3.

A richiesta: cerniere a scomparsa 3D. tre per anta anche nelle altre versioni.

** Le tonalità del colore presenti nel catalogo non sono vincolanti ai fini della fornitura delle porte stesse, in quanto riportate con un procedimento di stampa.*

Il Legno produce anche porte ACUSTICHE CERTIFICATE e porte REI CERTIFICATE, realizzate con la maggior parte delle finiture presenti in questo catalogo.

***DA UN AMBIENTE
ALL'ALTRO
CON "IL LEGNO"***

 290





■ 242



■ 248



**PANNELLO DISPONIBILE IN MOLTEPLICI
VARIANTI GRAFICHE, CON POSSIBILITÀ DI
INCISIONI PERSONALIZZATE SU RICHIESTA**
(solo su un minimo d'ordine fisso concordato).

296





■ 269



■ 295



245/3



**Vedi le possibili varianti grafiche a pagina 22-23.*



■ 241



■ 297

***ELEGANZA E
CARATTERE IN PORTE
CHE PARLANO DI TE.***



■ 245/2
Versione roto



■ 299



■ 290/2

287 



LAVORAZIONE TRIDIMENSIONALE EFFETTO GRAFFIO: le incisioni variano da una profondità minima alle estremità per poi intensificarsi al centro fino a raggiungere i 6,5 mm. Per le porte incise pesanti è di serie la cerniera a scomparsa 3D.

244



LAVORAZIONE TRIDIMENSIONALE
EFFETTO GRADUALE: il pannello viene realizzato con incisioni che giocano su diverse profondità, creando un interessante effetto sia visivo che tattile.





289





203



204

**QUANDO IL DESIGN
INCONTRA
LA CREATIVITÀ.**



201 





■ 298



■ 206



■ 208

266



267

***LA SCELTA D'ARREDAMENTO
CHE DEFINISCE CHI SEI.***



280



281



■ 278



■ 279



**LAVORAZIONE DEL PANNELLO:
PROFONDITÀ INCISIONE 3 MM.**

**Vedi le possibili varianti grafiche a pagina 22-23.*

277 ■





■ A libro



■ Scorrevole a incasso



■ Roto



■ Scorrevole esterno muro con o senza controbattuta

■ Scorrevole esterno muro con guida invisibile (solo nelle versioni cieco/liscio)



■ Scorrevole esterno muro con guida in alluminio e pattino a scomparsa (realizzabile solo su alcuni modelli)

TELAI IN LEGNO

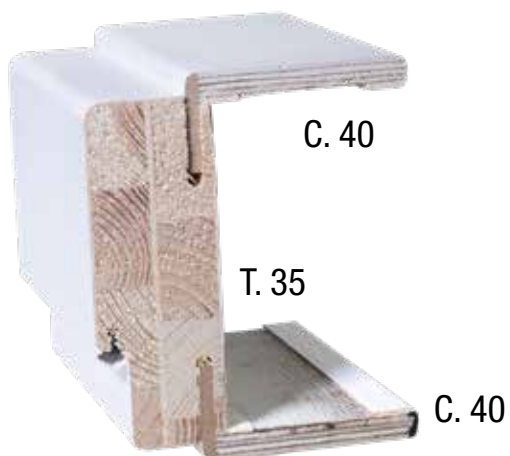

Telaio standard

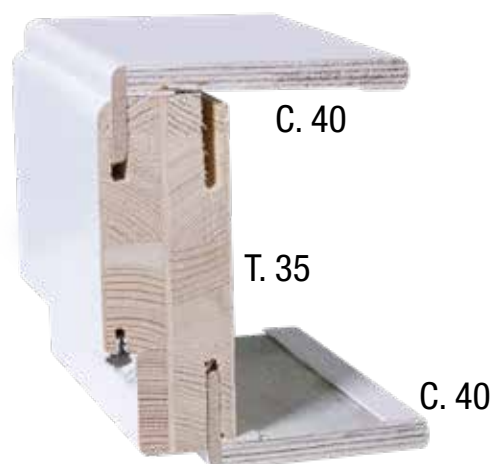

Telaio standard + cornice PLUS

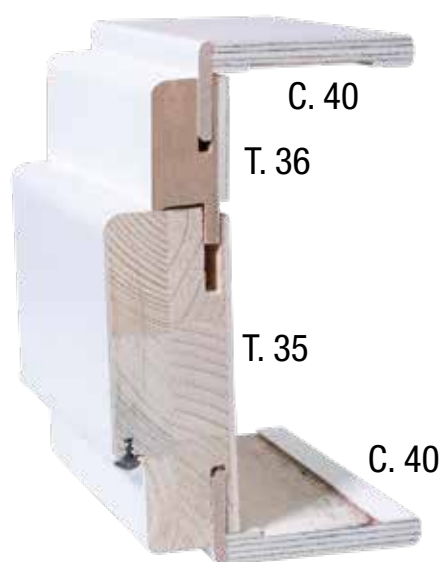

Telaio con allargamento

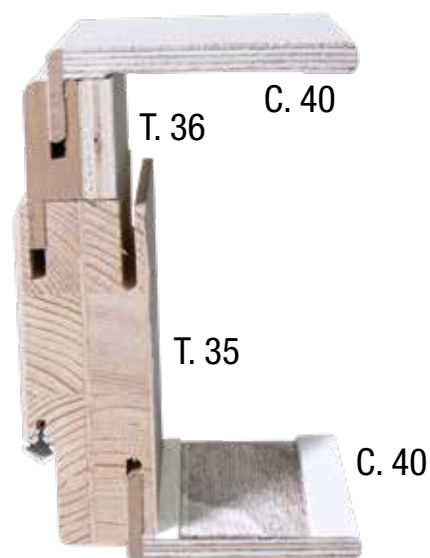

Telaio con allargamento + cornice PLUS



Telaio a madonna

VARIANTI GRAFICHE: MICROINCISIONI

■ 201

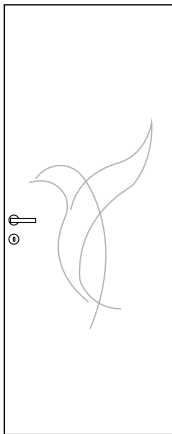

■ 202

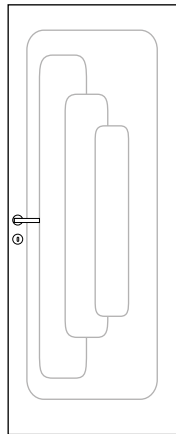

■ 203

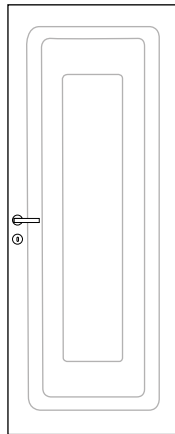

■ 204

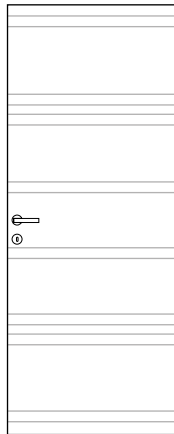

■ 205

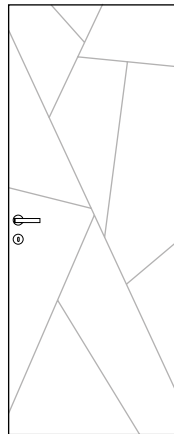

■ 206

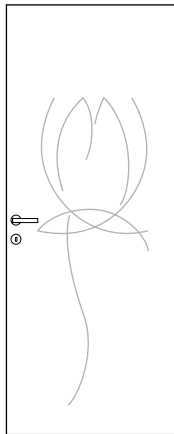

■ 208

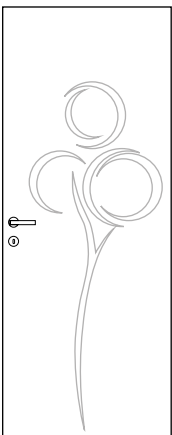

■ 228

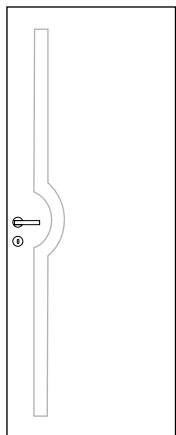

■ 238/2

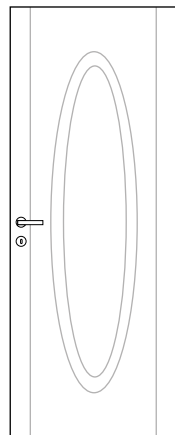

■ 240

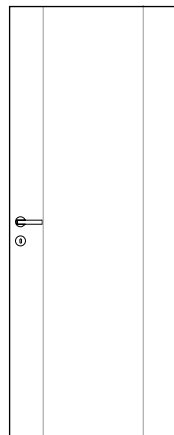

■ 241

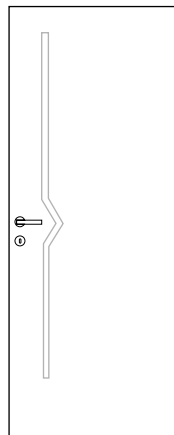

■ 242

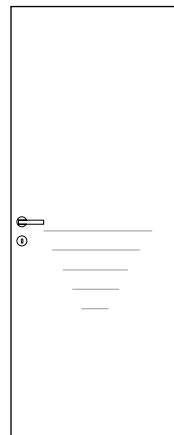

■ 245/2

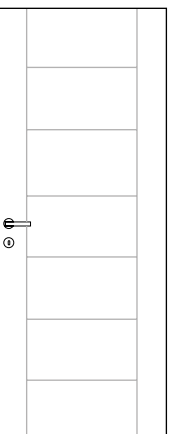

■ 245/3

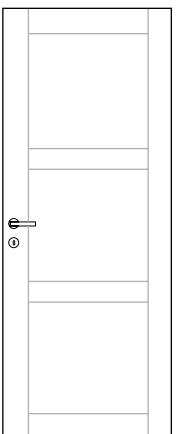

■ 246

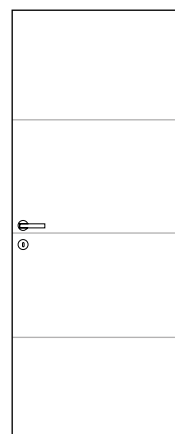

■ 247/3

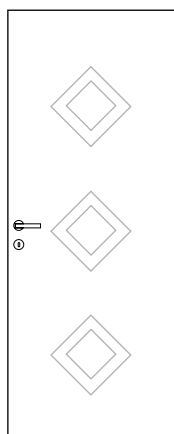

■ 248

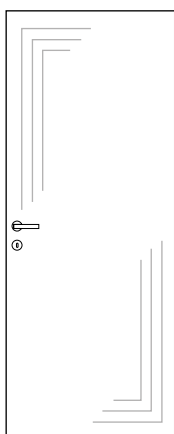

■ 255

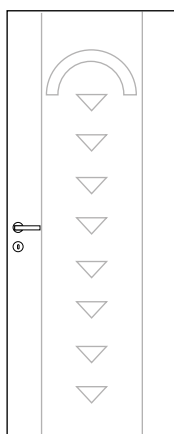

■ 266

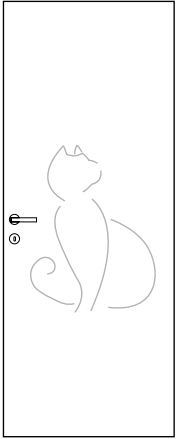

■ 267

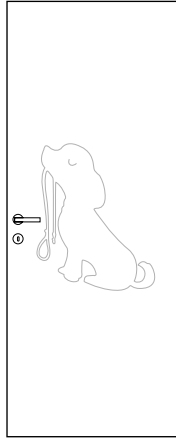

■ 269

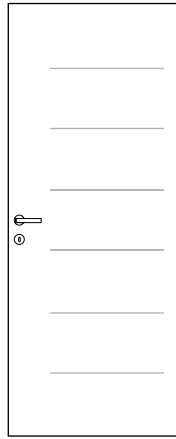

■ 277

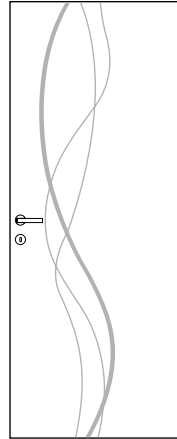

■ 278

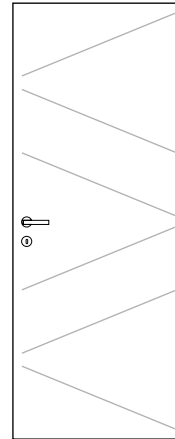

■ 279

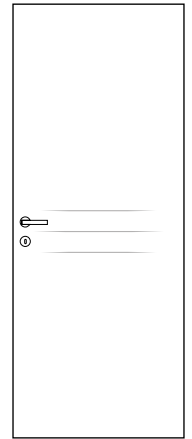

■ 280

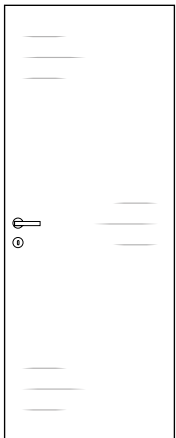

■ 281

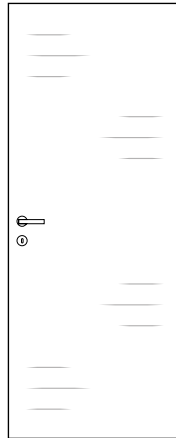

■ 290

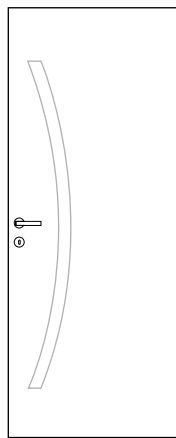

■ 290/2

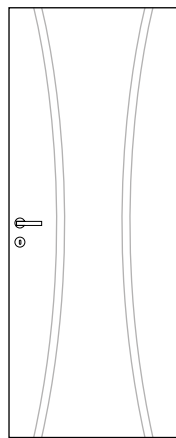

■ 295

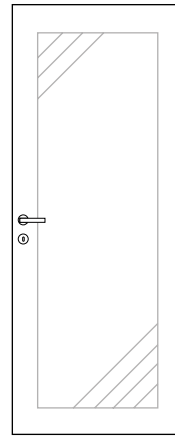

■ 296

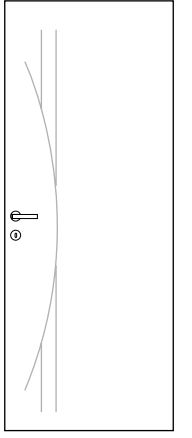

■ 297

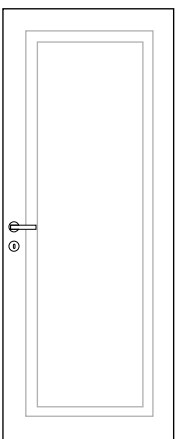

■ 298

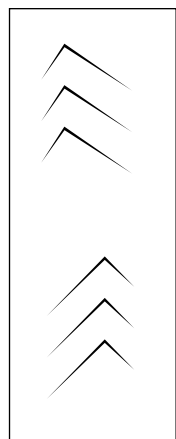

■ 299

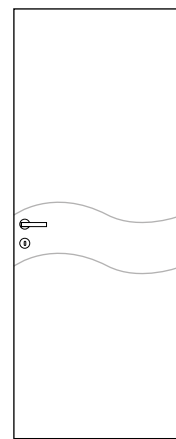

■ 244

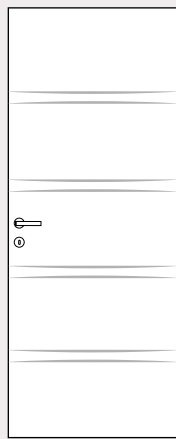

■ 287

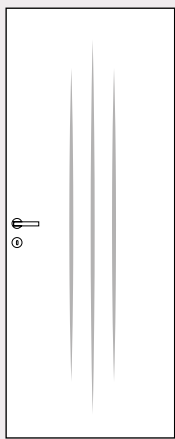

■ 289

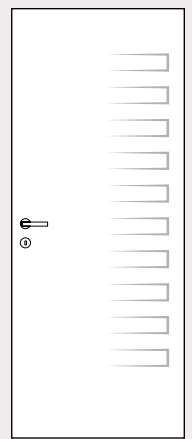

INCISE PESANTI

SISTEMI DI APERTURA/CHIUSURA e MISURE

Scorrevole incasso sx

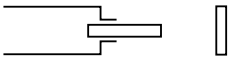

Scorrevole incasso dx

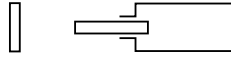

Scorrevole incasso doppia anta

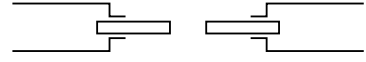

Scorrevole esterno muro sx

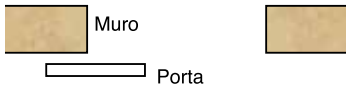

Scorrevole esterno muro dx

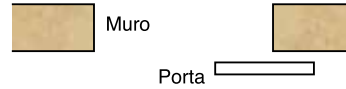

Aumenta lo spazio "Di qua - Di là - Roto"

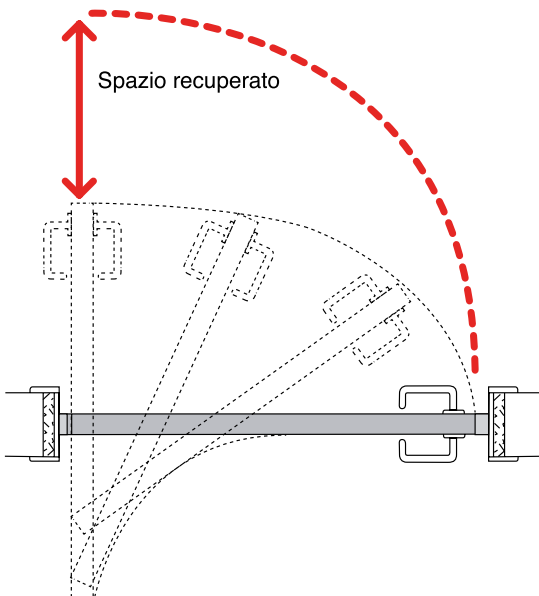

Apertura "via-vai" (saloon)

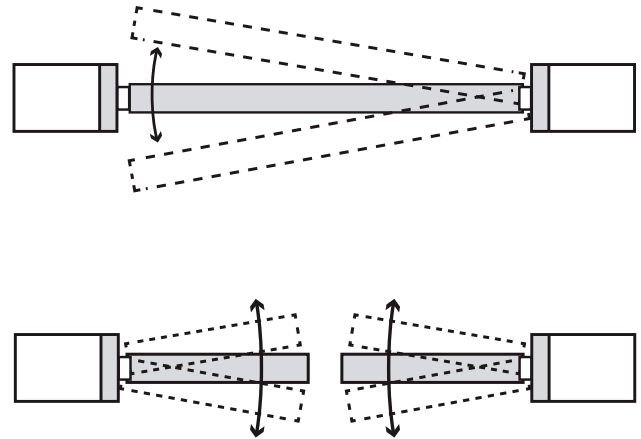

Senso di apertura porta classica

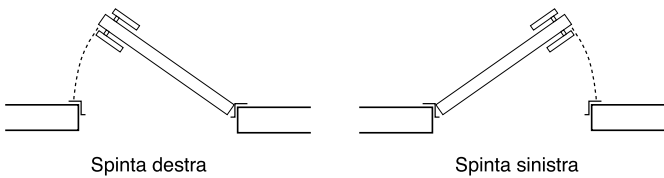

Senso di apertura porta a libro

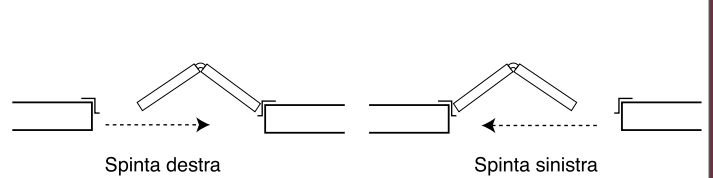

MISURE STANDARD E A SUPPLEMENTO

Misura foro muro minima: 69 - 74 - 79 - 84 - 89 - 94 - 99 - 109 x 215

Misure passaggio 60 - 65 - 70 - 75 - 80 - 85 - 90 - 100 x 210 x 10,7

Realizzazioni a misura, in doppia anta, con sopra luce e per i modelli lisci è possibile la versione in pendenza.

FINITURE e SERRATURE/CERNIERE

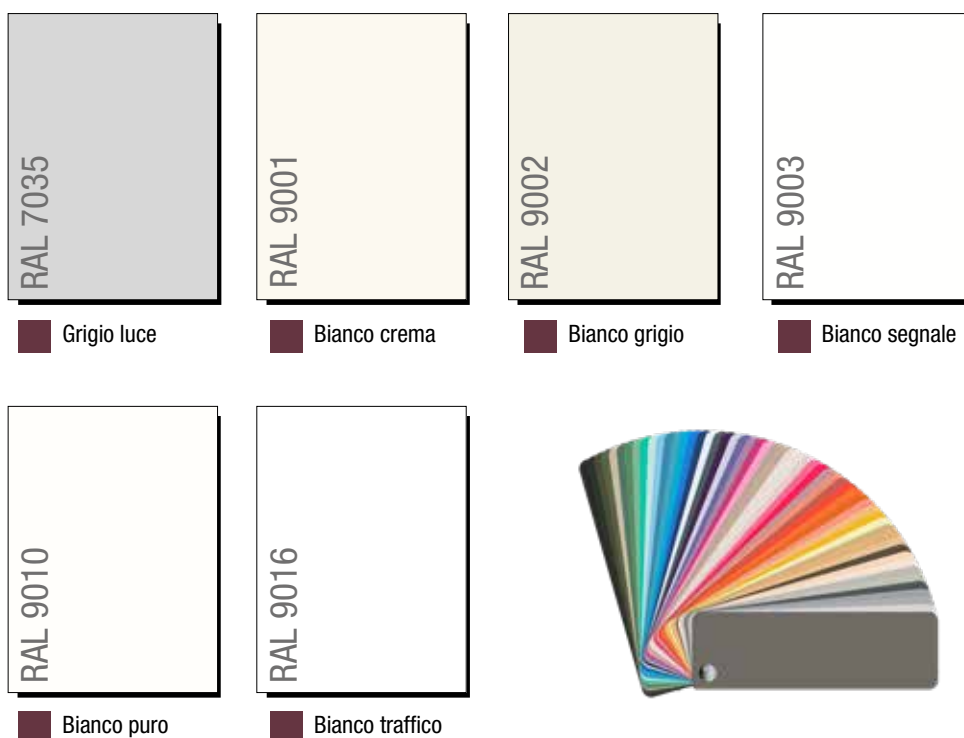

Le porte della Linea INCISE sono realizzate nelle tonalità neutre sopra indicate, ma possono essere personalizzate in tutte le colorazioni RAL e NCS, su specifica richiesta del cliente.

Dettagli di alcune realizzazioni:



** Le tonalità di colore presenti nel catalogo non sono vincolanti ai fini della fornitura delle porte stesse, in quanto riportate con un procedimento di stampa.*



MANIGLIE



■ ROBOT



■ MILLA_LC31



■ ROBOQUATTRO



■ ROBOQUATTRO S



■ ROBOCINQUE



■ ROBOCINQUE S



ELLE



ELLESSE



TAIPAN

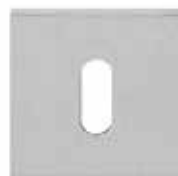

ALBA



ESPRIT



FEDRA



Via Robert Fulton, n.9
40017 - San Giovanni in Persiceto
Bologna (ITALIA)

Tel. +39 051 6810988
Tel. +39 051 734959
Fax +39 051 6811343

info@italialegno.it
www.italialegno.it

