



Collezione porte  
**LINEA FASHION**



Versione 0017



AZIENDA CON SISTEMA DI QUALITÀ  
CERTIFICATO UNI EN ISO 9001





## LA NOSTRA AZIENDA

Sin dal 1976 la nostra azienda si dedica alla progettazione e produzione di porte di altissimo pregio, dagli elevati valori prestazionali e in una vasta gamma di modelli, finiture, essenze e laccati.

Costruite attraverso sistemi tecnologici all'avanguardia, le porte Il Legno si distinguono per gli elevati standard qualitativi caratteristici delle lavorazioni artigianali Made-in-Italy, grazie a cui è possibile realizzare prodotti esclusivi e su misura, a seconda delle esigenze del cliente, in grado di unire design, funzionalità, sicurezza ed affidabilità a lungo termine.

La selezione delle migliori materie prime nel pieno rispetto dell'ambiente, la consulenza tecnica fornita da esperti e la puntualità del servizio sono i principali fattori che nel corso del tempo hanno contribuito a rafforzare una filosofia aziendale basata sulla piena soddisfazione del cliente.

Le porte Il Legno sono in grado di armonizzarsi a qualsivoglia tipologia di ambiente, stile d'arredamento o preferenza estetica grazie all'ampio ventaglio di materiali, finiture e accessori offerti, ciascuno dei quali si contraddistingue per qualità e cura nei dettagli, entrambi elementi cardine nella realizzazione di ogni singolo prodotto.

La produzione Il Legno è inoltre completata da armadiature, complementi d'arredo e boiserie su misura, che consentono di realizzare ambienti dall'elevato valore funzionale ed estetico.



## COLLEZIONE "LINEA FASHION"

**Telaio** in legno listellare spessore mm. 40 raggio 3 con battuta, guarnizione, fresate per incastro coprifili.

**Coprifilo** lato interno da mm. 70x10, lato bello porta da mm. 90x10, entrambi con aletta ad incastro.

**Ante** spessore mm. 44 con massello perimetrale in abete giuntato FJ per eliminare i nodi e risacche di resina, supporti in MDF da mm. 4, alveolare in cartone resinato pesante a foro 20/25, tappi di rinforzo altezza serratura. Le ante sono spazzolate e incise o solo spazzolate senza incisioni standard laccato Bianco **RAL 9016**. Altre finiture/colorazioni RAL e/o NCS a scelta.

**Ferramenta** cromo satinato, cerniere a scomparsa in registrazione 3D, tre per anta, serratura magnetica.

*\* Le tonalità del colore presenti nel catalogo non sono vincolanti ai fini della fornitura delle porte stesse, in quanto riportate con un procedimento di stampa.*

**Il Legno produce anche porte ACUSTICHE CERTIFICATE e porte REI CERTIFICATE, realizzate con la maggior parte delle finiture presenti in questo catalogo.**



621  
Spazzolata  
e incisa  
Laccata  
RAL 9016  
opaco



**DA UN AMBIENTE  
ALL'ALTRO  
CON "IL LEGNO"**

652  
Spazzolata

621  
Spazzolata e incisa  
Laccata RAL 7040 opaco



652  
Spazzolata

***DESIGN DI IMPATTO  
IN COMPOSIZIONI ESCLUSIVE.***

621  
Spazzolata e incisa  
Laccata RAL 7035 opaco



652  
Spazzolata



621  
Spazzolata e incisa  
Laccata RAL 7034 opaco



Tutte le porte FASHION modello 652, sono realizzate con montanti da 13 cm e pannello centrale in vetro temperato satinato bianco.

■ 617 RIGA  
SAVIOLA  
(spazzolata)



Dettaglio della lavorazione del pannello tramite spazzolatura superficiale per conferire un leggero effetto venato piacevole al tatto e alla vista, con successiva laccatura in colorazione RAL o NCS a scelta.



617 RIGA  
RAL 1000   
(spazzolata)



***PERSONALITÀ ED ELEGANZA PER UNO STILE UNICO***







■ 617 RIGA  
7035  
(spazzolata)





■ Roto



■ Scorrevole a incasso



■ A libro



■ Scorrevole esterno muro con o senza controbattuta

# SISTEMI DI APERTURA/CHIUSURA e MISURE

Scorrevole incasso sx

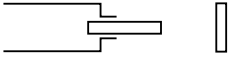

Scorrevole incasso dx

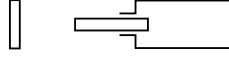

Scorrevole incasso doppia anta

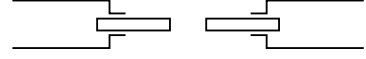

Scorrevole esterno muro sx

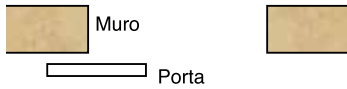

Scorrevole esterno muro dx

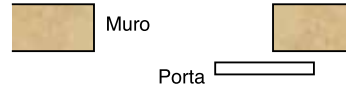

Aumenta lo spazio "Di qua - Di là - Roto"

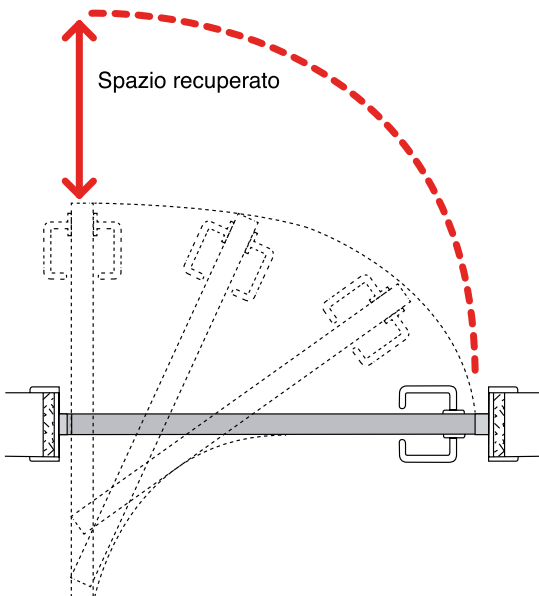

Apertura "via-vai" (saloon)

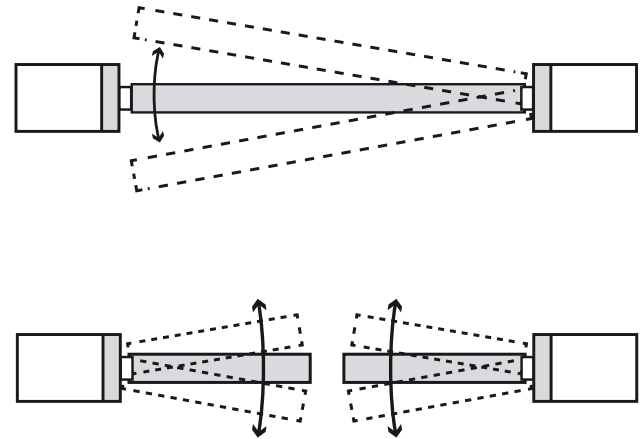

Senso di apertura porta classica

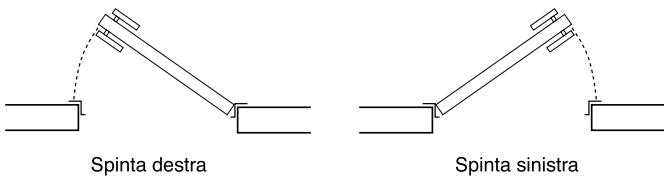

Senso di apertura porta a libro

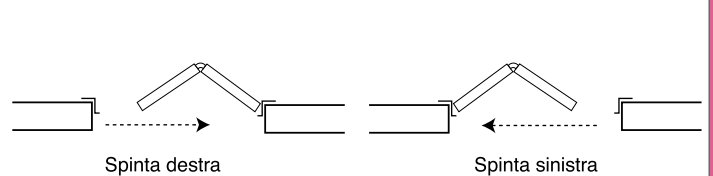

## MISURE STANDARD E A SUPPLEMENTO

Misura foro muro minima:

69 - 74 - 79 - 84 - 89 - 94 - 99 - 109 x 215

Misure passaggio

60 - 65 - 70 - 75 - 80 - 85 - 90 - 100 x 210 x 10,7

Realizzazioni a misura, in doppia anta, con sopra luce e per i modelli lisci è possibile la versione in pendenza.



SERRATURA MAGNETICA E CERNIERA A SCOMPARSA 3D:  
di serie su tutti i modelli della "LINEA FASHION".

# FINITURE



Le porte della Linea FASHION sono realizzate di serie nella tonalità RAL 9016, ma possono essere personalizzate in tutte le colorazioni RAL e NCS, su specifica richiesta del cliente con relativo supplemento.



 RAL 9016

Colori PERSONALIZZATI

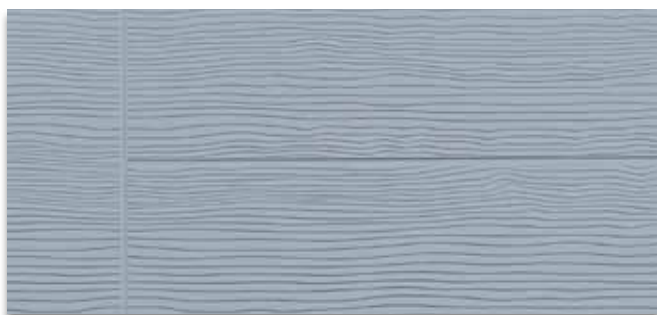

 RAL 7040

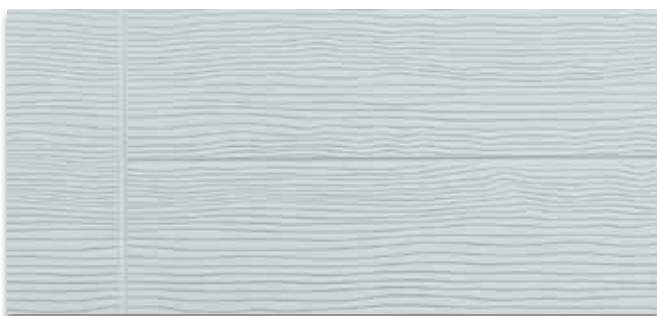

 RAL 7035



 RAL 7034

*\* Le tonalità di colore presenti nel catalogo non sono vincolanti ai fini della fornitura delle porte stesse, in quanto riportate con un procedimento di stampa.*

# MANIGLIE



**ROBOT**



**MILLA\_LC31**



**ROBOQUATTRO**



**ROBOQUATTRO S**



**ROBOCINQUE**



**ROBOCINQUE S**



ELLE



ELLESSE



TAIPAN

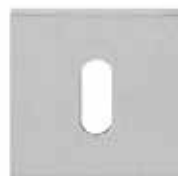

ALBA



ESPRIT



FEDRA



Via Robert Fulton, n.9  
40017 - San Giovanni in Persiceto  
Bologna (ITALIA)

---

Tel. +39 051 6810988  
Tel. +39 051 734959  
Fax +39 051 6811343

[info@italialegno.it](mailto:info@italialegno.it)  
[www.italialegno.it](http://www.italialegno.it)

